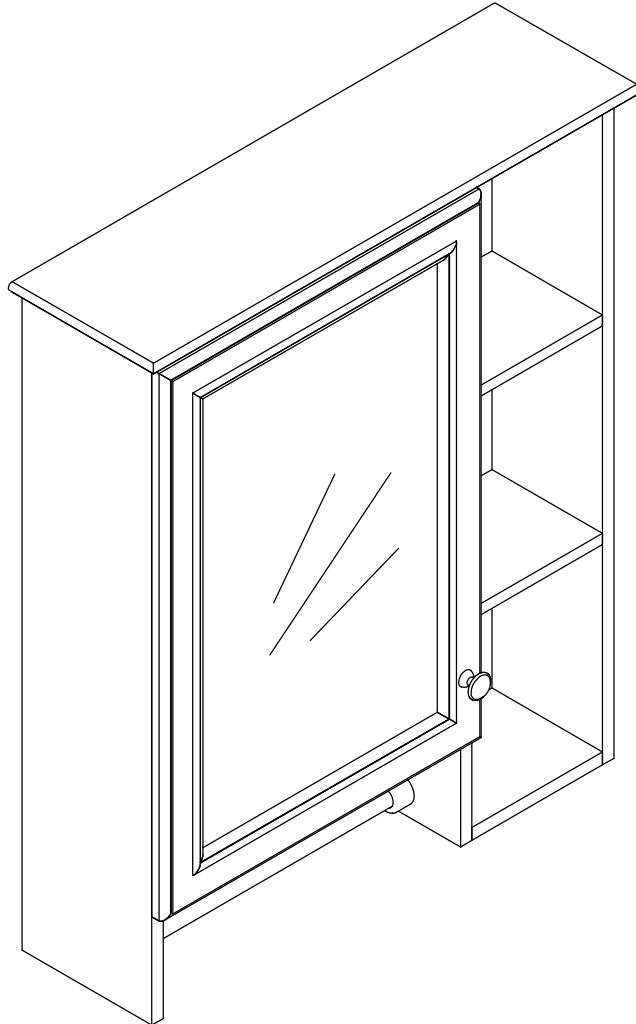


ASSEMBLY INSTRUCTIONS

24 INCH MIRROR CABINET

HERMITAGE BATH

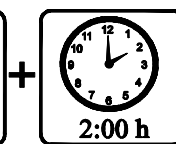
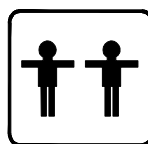
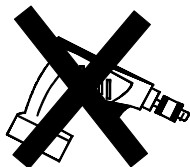


Thank you for purchasing this quality product. Be sure to check all packing material carefully for small parts which may have come loose inside the carton during shipment. Separate, identify and count all parts and hardware.

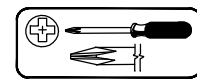
Compare with the parts list to be sure all parts are present.

"DO NOT TIGHTEN SCREWS UNTIL COMPLETELY ASSEMBLED"

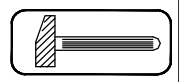
*** Use of power tool to assemble this product will invalidate any claim and damage this product making unsafe !!!**
*** Please assemble on a clean soft surface to avoid damage.**



Tools Required



(Not included)



(Not included)

IMPORTANT:

PLEASE READ INSTRUCTION BEFORE STARTING THE ASSEMBLY

Before Installation

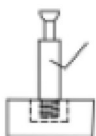
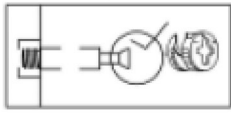
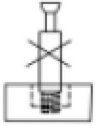

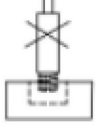
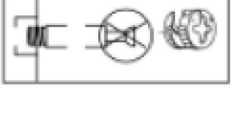
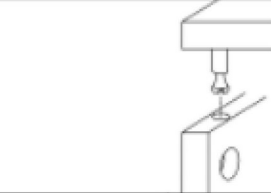
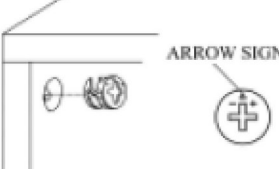
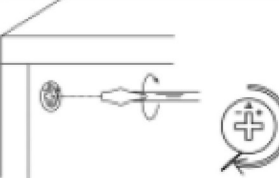
Important - Please read these instructions fully before starting assembly

Thank you for purchasing this quality product. Be sure to check all packing materials carefully for small parts, which may have come loose inside the carton during shipment. Identify and count all items according to the PARTS LIST and/or HARDWARE LIST shown below. Check you have all the components and tools listed on the following pages.

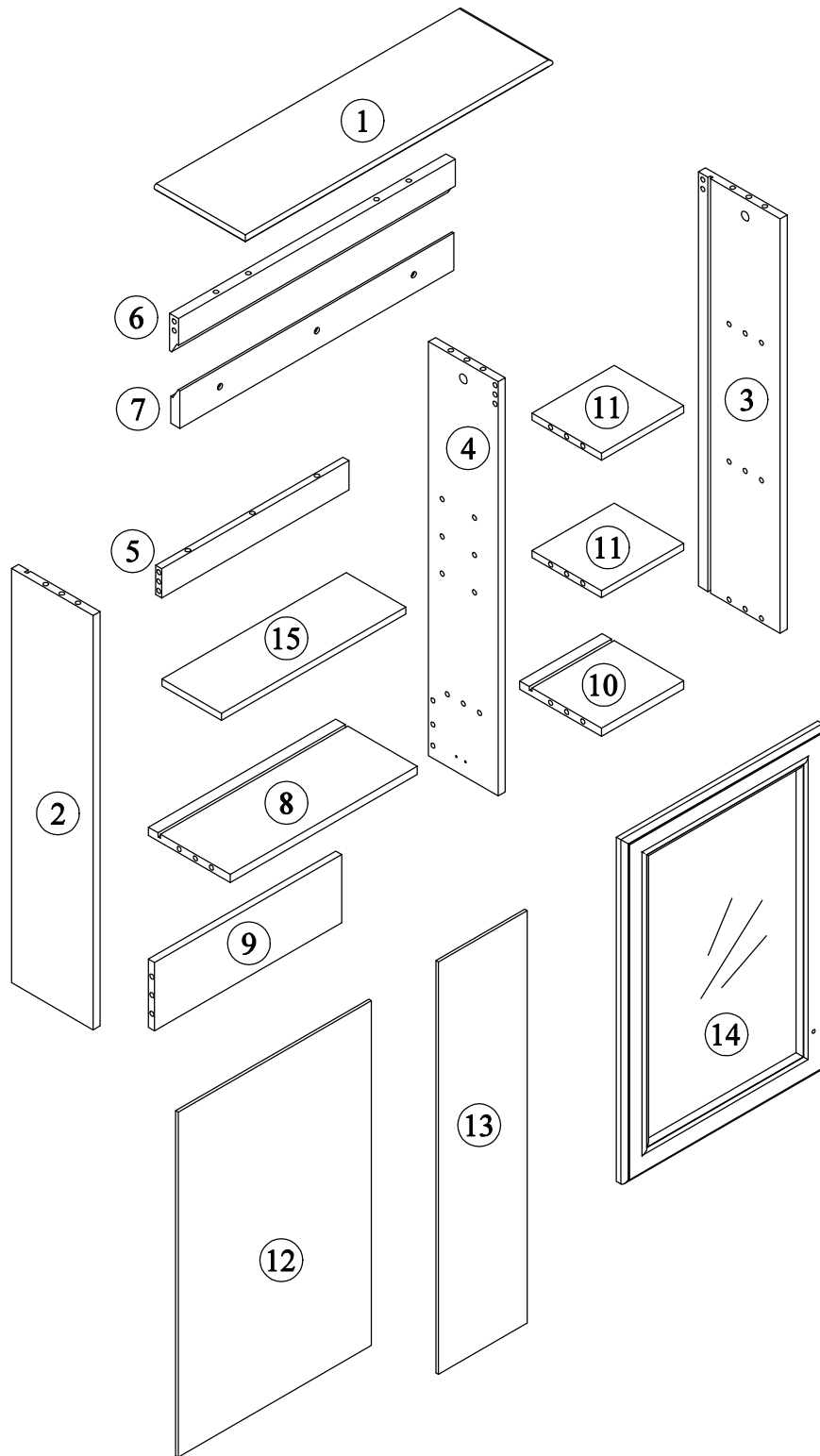
- . We recommend that you assemble this product with the assistance of another person; this will make the assembly easier, and will help eliminate damage to the product or injury to persons during assembly.
- . Please do not over tighten screws or bolts until the assembly is completed.
- . Keep children and animal away from the work area, small parts could choke if swallowed.
- . Please put all parts on a non-abrasive floor before assembly, and follow the assembly steps to assemble your newly purchased product correctly and efficiently.

If you find that you have any trouble with assembly or missing or damaged parts please contact the seller.

Cam Lock Assembly Instructions

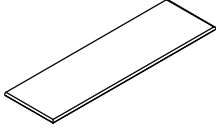
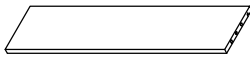
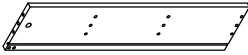
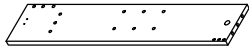
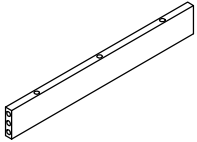
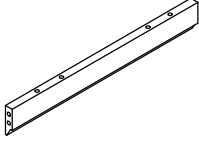
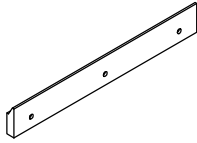
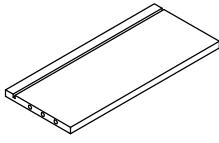
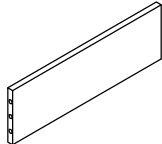
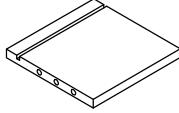
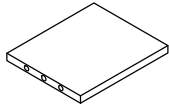
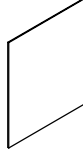


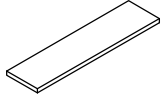
		Diagram A Insert Cam Bolt into hole as shown in diagram A.
		Diagram B Make sure not to insert the Cam Bolt: Too deep as shown in figure B as this will cause the Cam Lock to be misaligned and unable to interlock properly.
		Diagram C Also avoid inserting the Cam Bolt too close to the surface of the hole as shown in figure C, as this will cause the Cam Lock to be too loose, and not interlock properly.
		Connect the panels together.
		ARROW SIGN Insert the Cam Lock so the side opening fits over the head of the Cam Bolt.
		To tighten the Cam Lock, turn it clockwise on half a turn with a flat screwdriver. <i>*Do not use an automatic screwdriver as it may bend or break if too much power is imposed.</i>

Detail View - CABINET

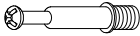



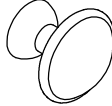
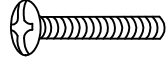
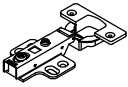
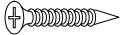



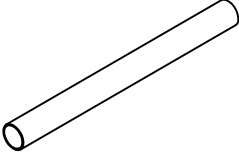
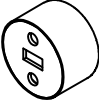
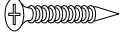



Identifying the Hardware-Identify the hardware using the illustrations below.

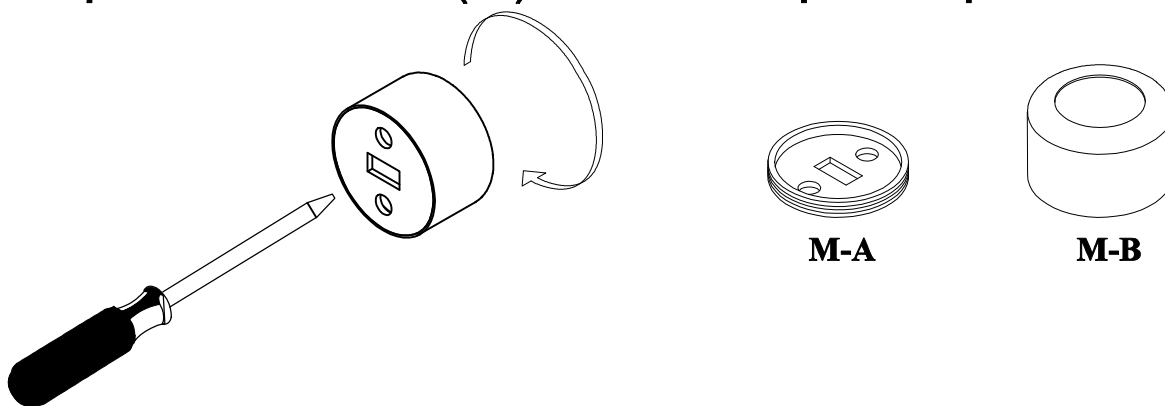
Part List - N710P401340

<p>1</p>  <p>Top Panel - 1pc</p>	<p>2</p>  <p>Side Panel Left - 1pc</p>
<p>3</p>  <p>Side Panel Right - 1pc</p>	<p>4</p>  <p>Mid Panel - 1pc</p>
<p>5</p>  <p>Front Top Bar - 1pc</p>	<p>6</p>  <p>Rear Top Bar - 1pc</p>
<p>7</p>  <p>Connect Bar - 1pc</p>	<p>8</p>  <p>Bottom Panel Left - 1pc</p>
<p>9</p>  <p>Bottom Panel Rear - 1pc</p>	<p>10</p>  <p>Bottom Panel Right - 1pc</p>
<p>11</p>  <p>Panel Mid Right - 2pcs</p>	<p>12</p>  <p>Back Panel Left - 1pc</p>
<p>13</p>  <p>Back Panel Right - 1pc</p>	<p>14</p>  <p>Door Cabinet - 1pc</p>
<p>15</p>  <p>Adjustable Shelf - 1pc</p>	

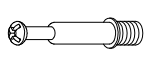


Hardware List - N710P401340

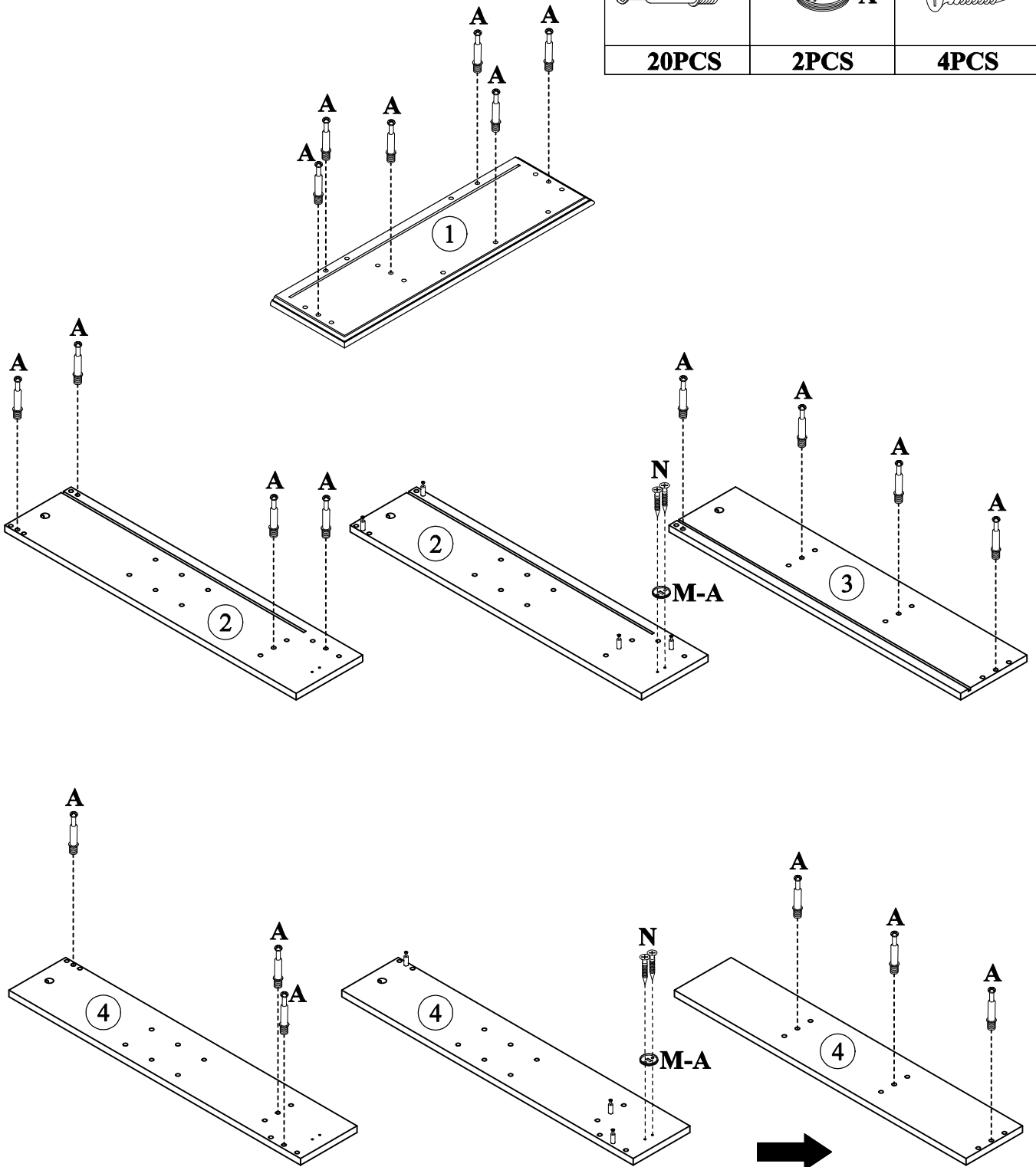
A  ø6x35mm	B  ø14.5x9mm	C  ø10xø5x50mm
Three in one bolts (20pcs)	Three in one lock (20pcs)	Flat head screw (3pcs)
D  ø12x55mm	E  Handle (1pc)	F  ø5/32"x20mm
Plastic stopper (3pcs)	Handle (1pc)	Handle screw (1pc)
G  Damping hinge (2pcs)	H  ø7xø3.5x15mm	I  Laminate pad(4pcs)
Damping hinge (2pcs)	Flat head screw (12pcs)	Laminate pad(4pcs)
J  ø8x30mm	K  ø7xø3.5x15mm	L  Steel Pipe (1pc)
Wood dowel (24pcs)	Round head screw(2pcs)	Steel Pipe (1pc)
M  Pipe Bracket (2pcs)	N  ø6xø3x12mm	O  ø6x30mm
Pipe Bracket (2pcs)	Flat head screw (4pcs)	Wood dowel (12pcs)

Expand hardware (M) into two separate parts

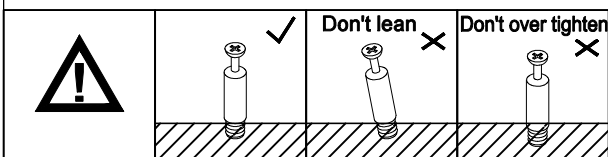


STEP: 1


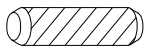
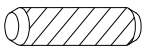
A	M	N
		
20PCS	2PCS	4PCS

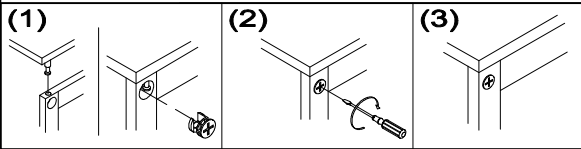
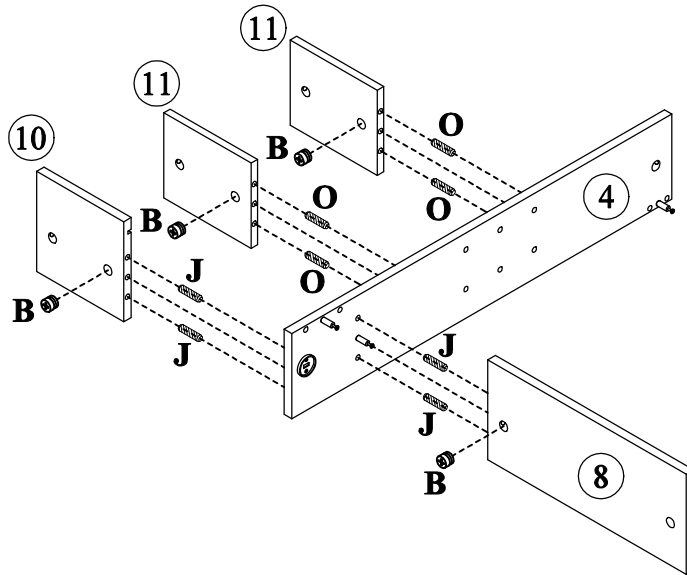


Turn over and install screws (A)






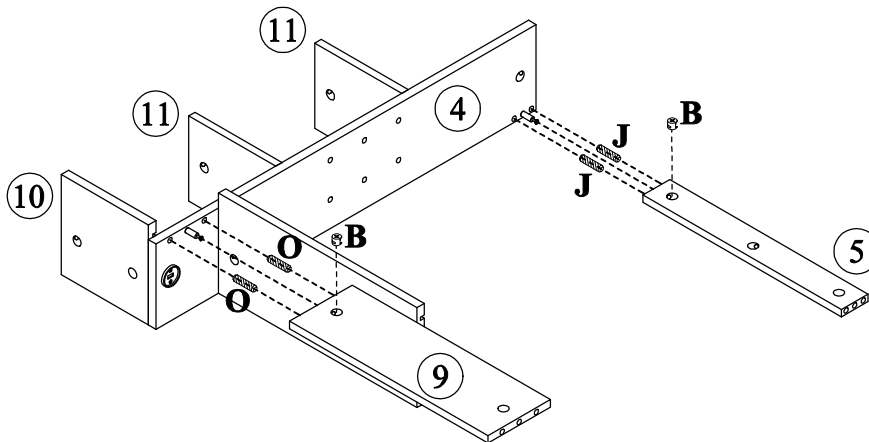
STEP: 2

B		J		O	
4PC		4PCS		4PCS	

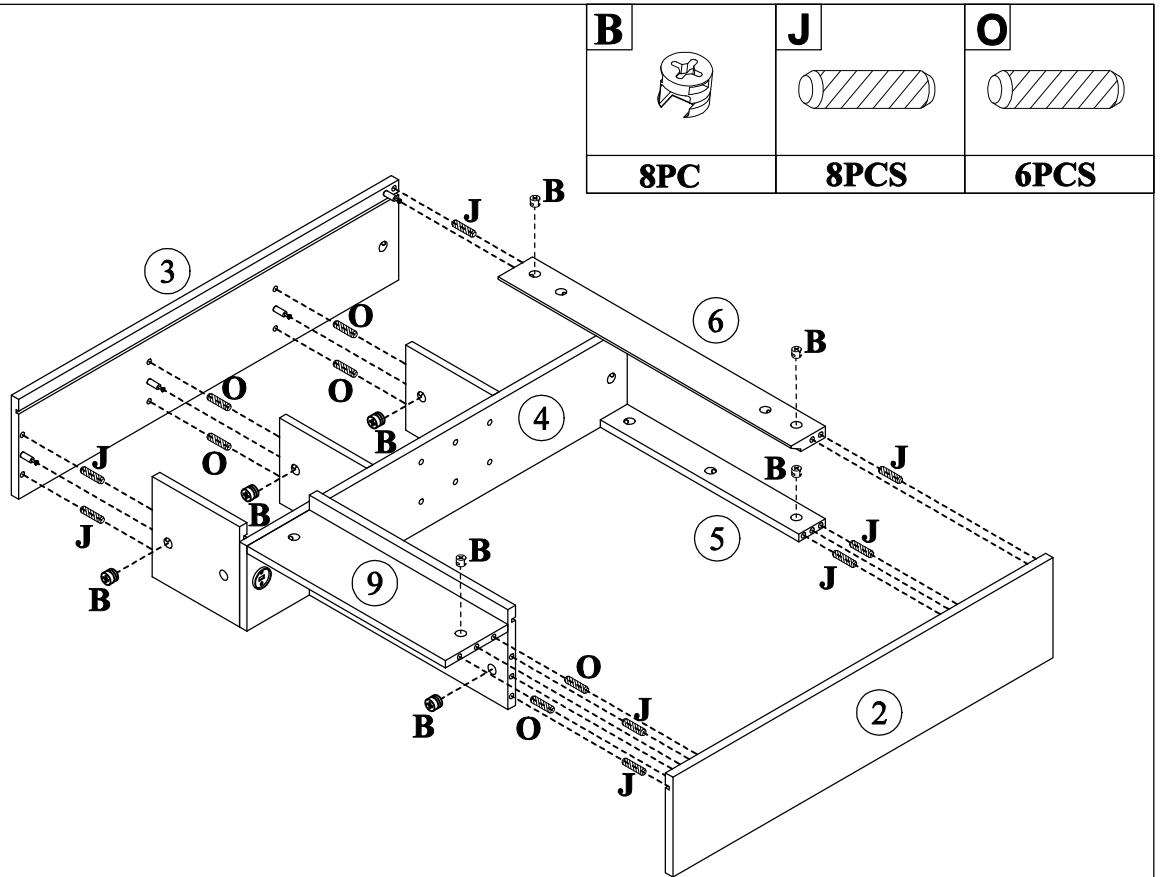


STEP: 3

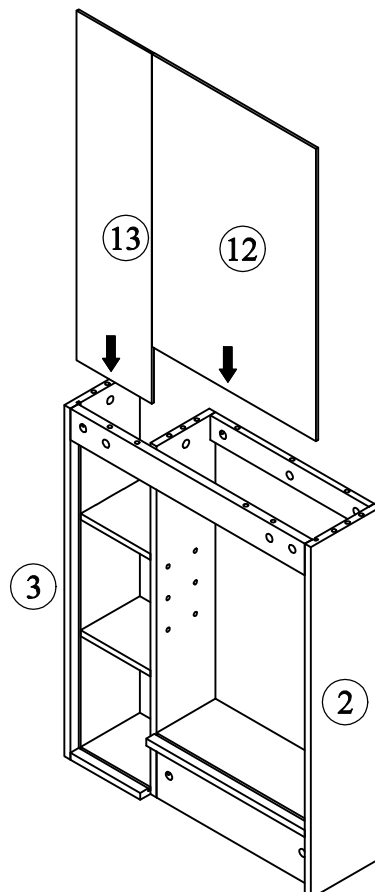
B		J		O	
2PC		2PCS		2PCS	




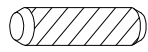
STEP: 4

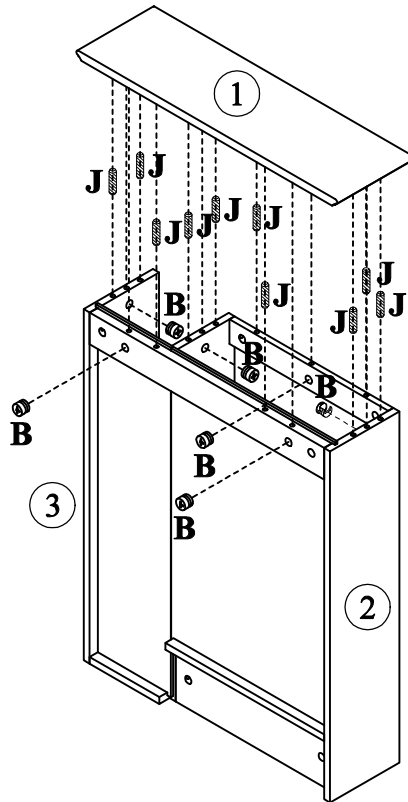


STEP: 5




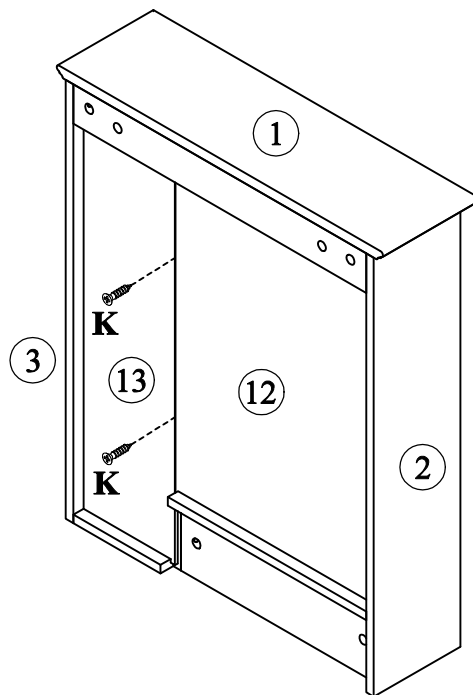
STEP: 6

B		J	
6PC		10PCS	

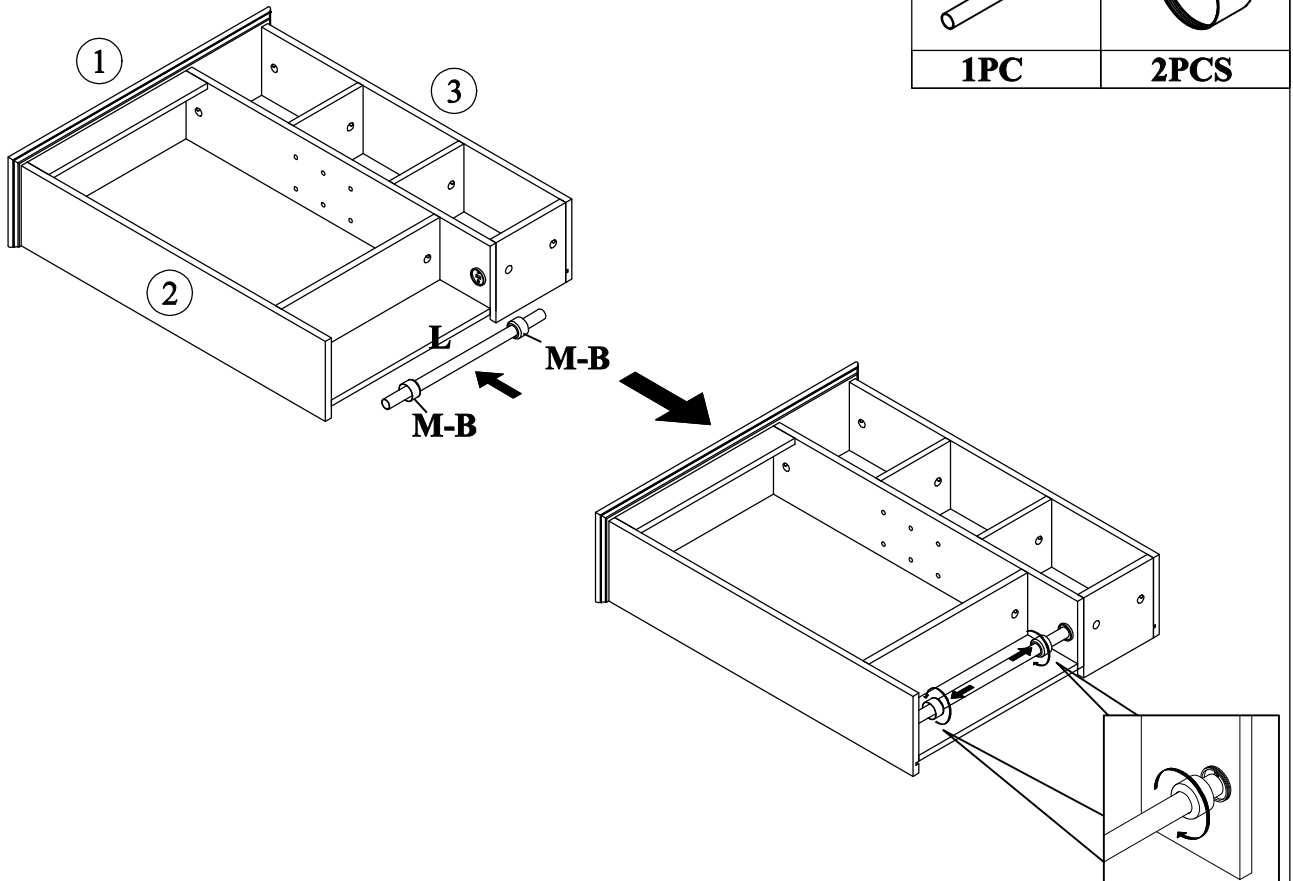


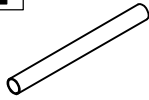

STEP: 7

K	
2PCS	

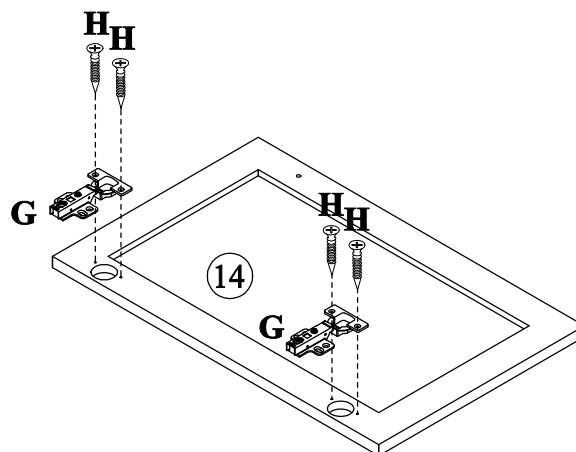




STEP: 8




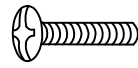

L 	M 
1PC	2PCS

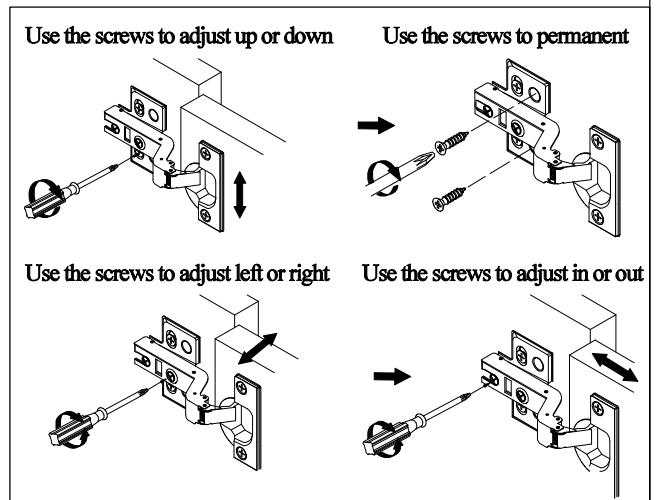
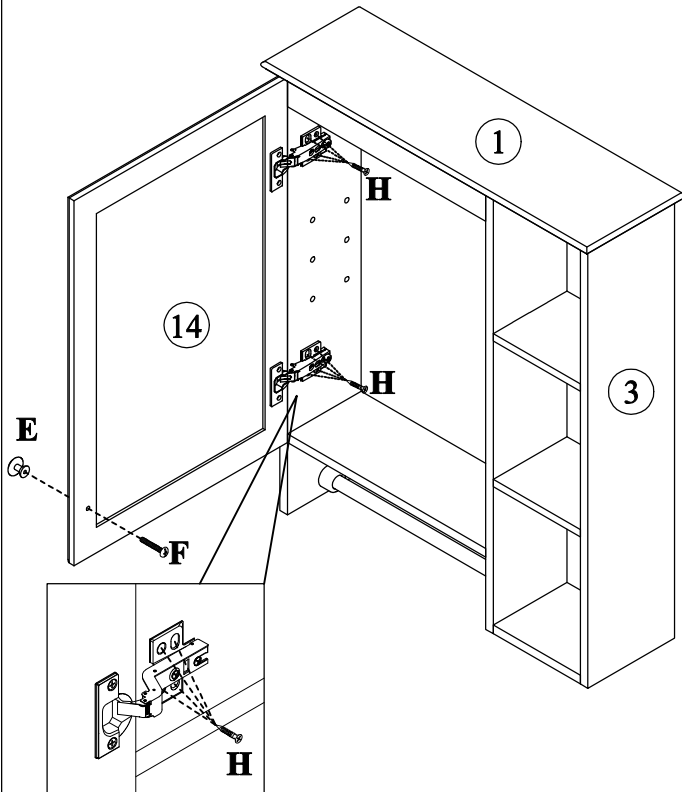
STEP: 9



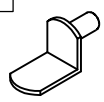
G 	H 
2PCS	4PCS

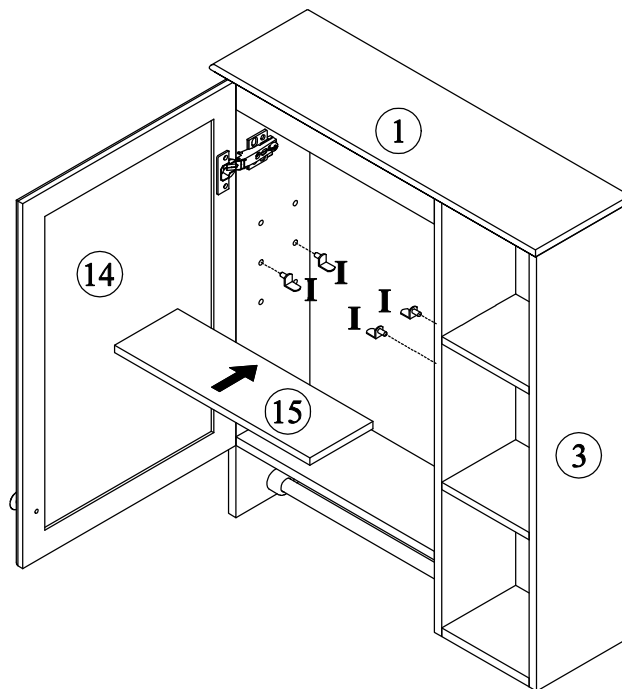
STEP: 10

E	F	H
		
1PC	1PC	8PCS

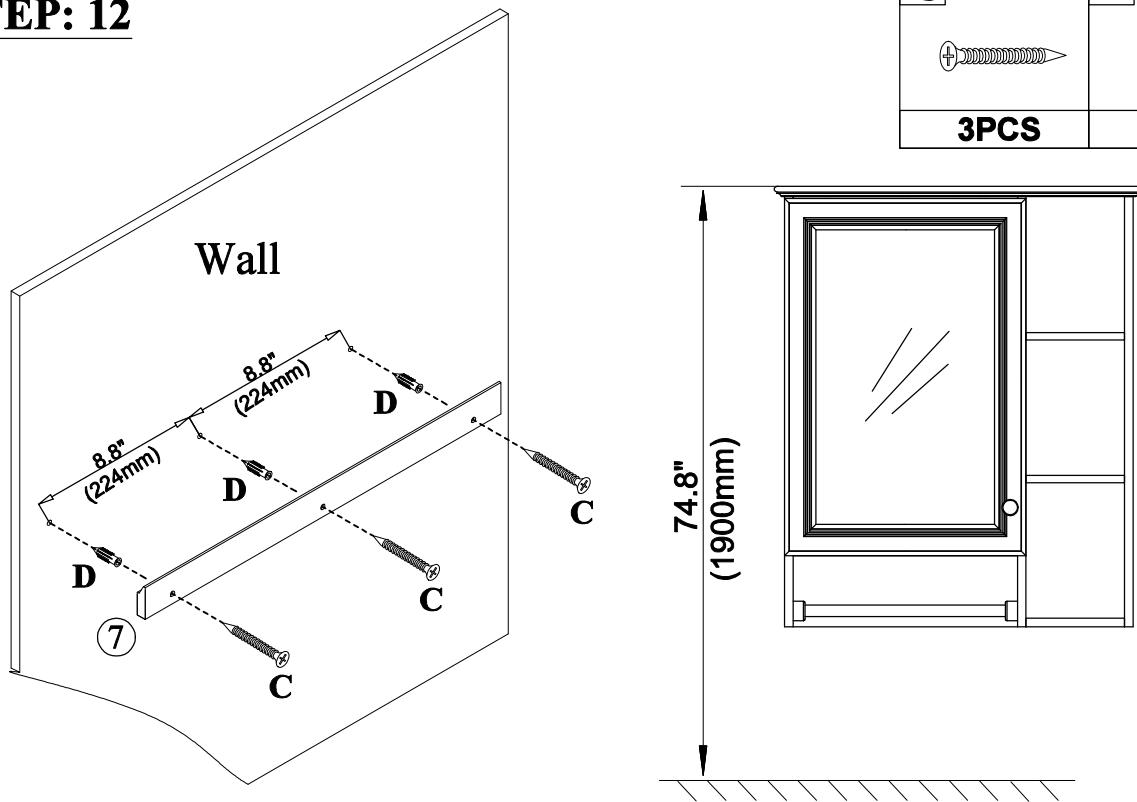


STEP: 11

I

4PCS



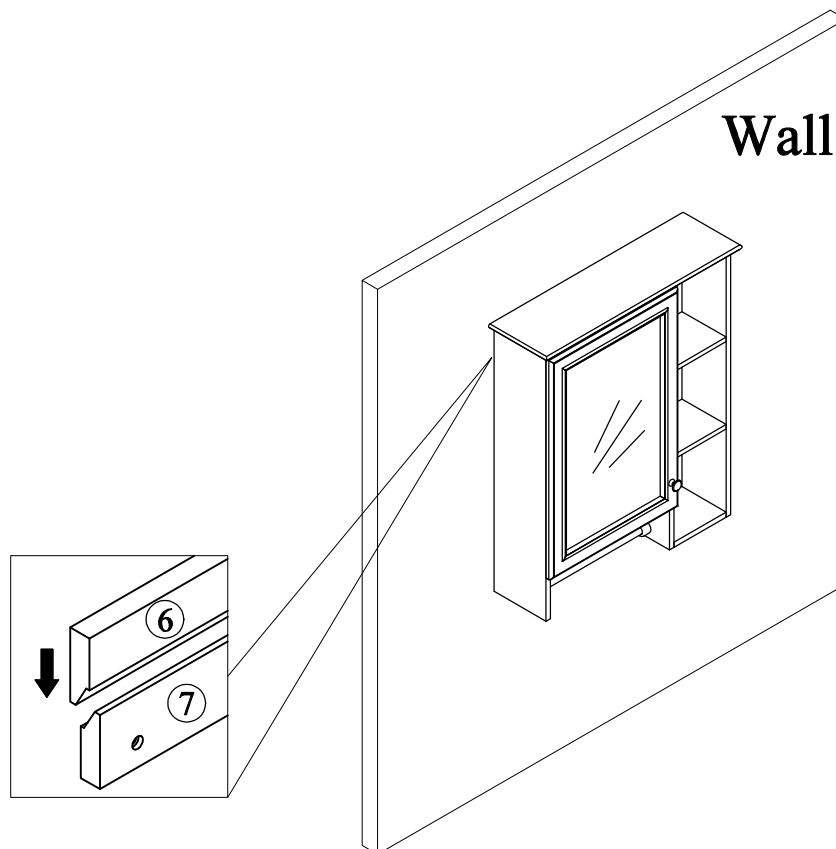
STEP: 12



Draw the spacing between the walls and the No.7, punch holes in the wall, and fix the No.7 to the wall with screws.

Note: Appropriate distance from the top of cabinet to the ground is 74.8".

STEP: 13



STEP: 14

