

Installation Manual

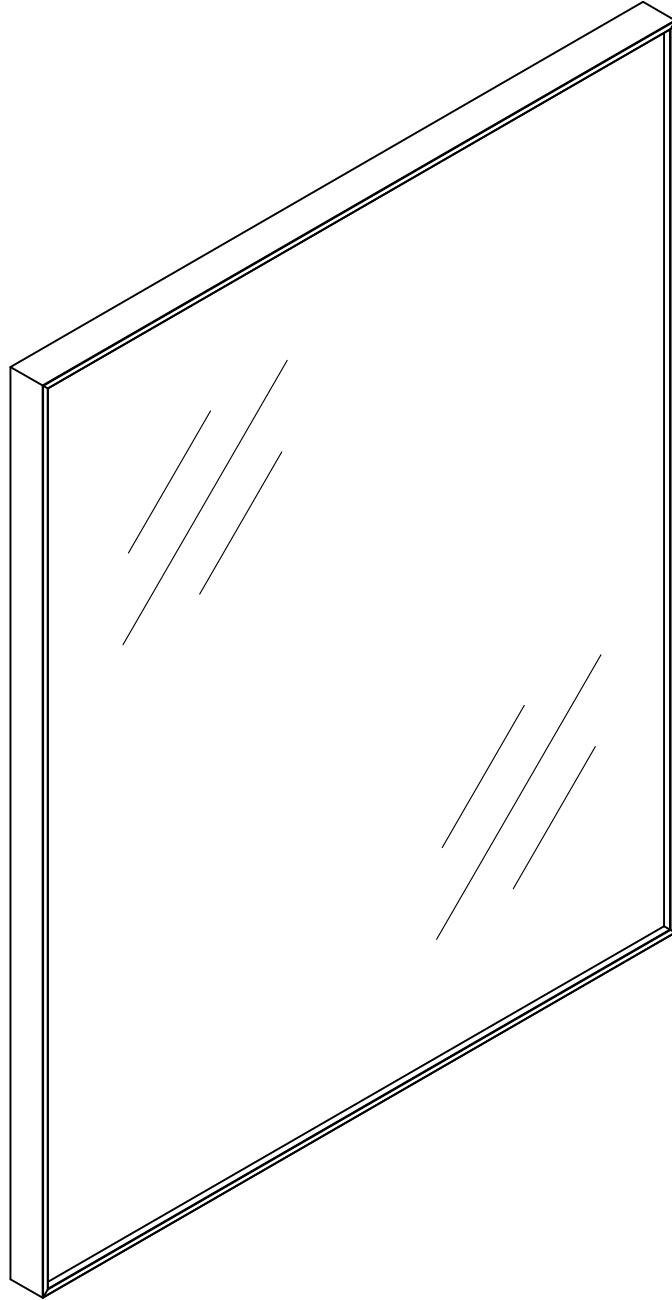

Detailed Diagram of Aluminium Mirror Components

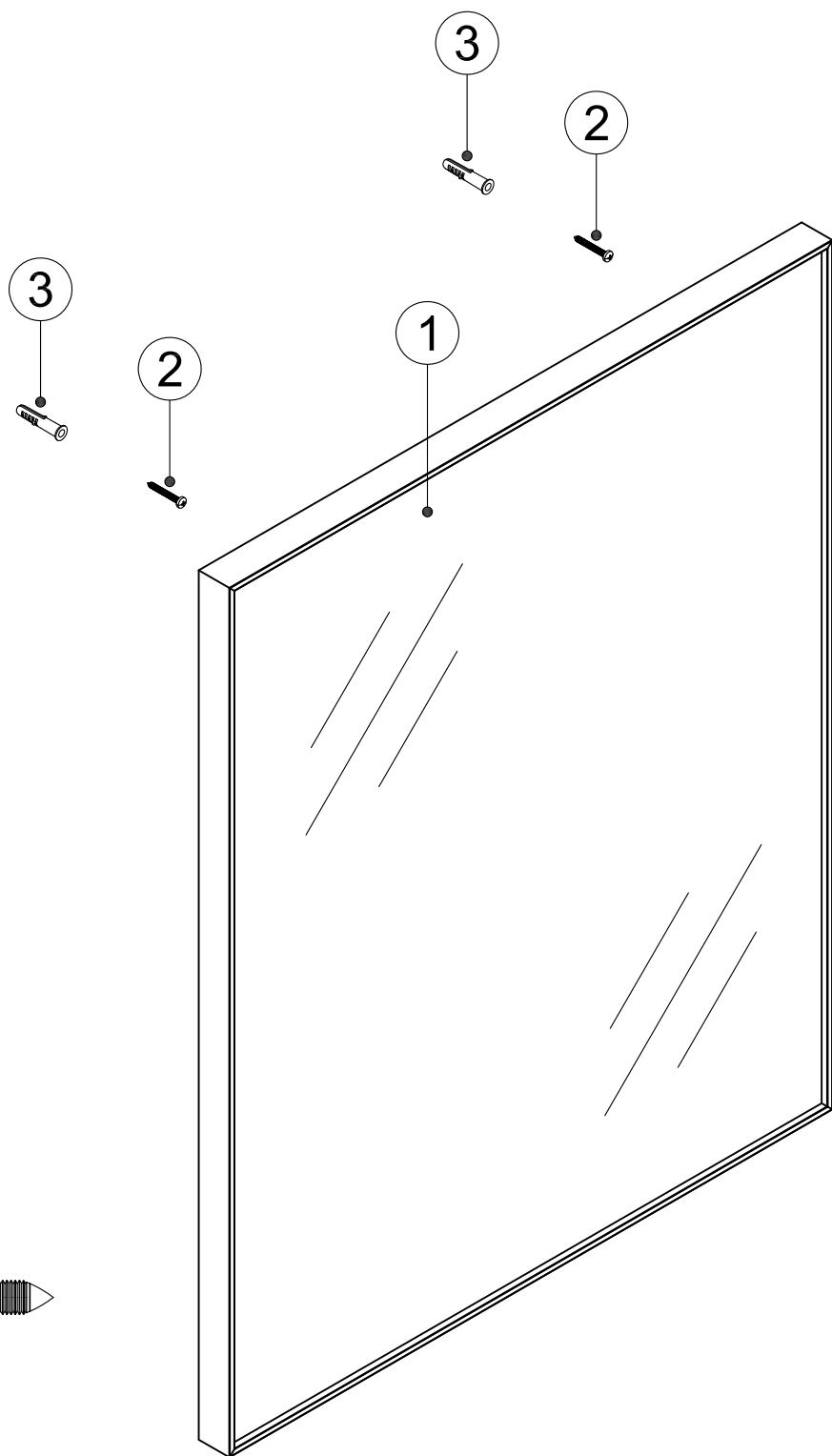

② SCREW 1 1/2"





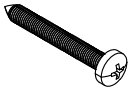
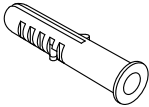
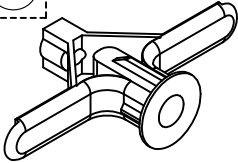

PARTS LIST

			
MIRROR(1 PCS)	1 1/2" SCREW(2 PCS)	WALL PLUG(2 PCS)	AIRCRAFT-SHAPED WALL PLUG(2 PCS)

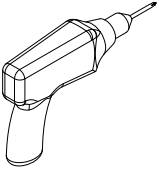
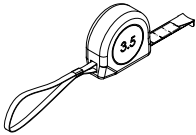
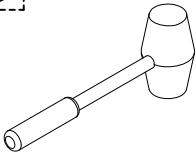
WARNING: Safety glasses should always be worn when working with drill.

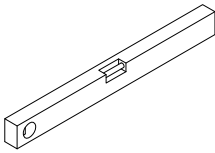
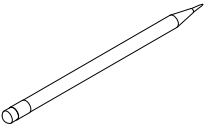
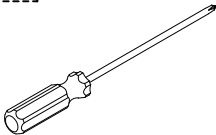
Required Tools:

			 5/16" & 3/8"	
DRILL	MEASURE TAPE	RUBBER MALLET	DRILL BITS	LEVEL
				
PENCIL	SCREW DRIVERS	SAFETY GLASSES		

Before You Start

Thank you for choosing our Aluminium Mirror. We hope to provide you with the most satisfying product and user experience.

Please read through this manual carefully as it contains important product information and step-by-step instructions on how to install this product. Fail to follow certain conditions of the instruction may affect the warranty of the product.

1. Prior to installation, please inspect boxes for damages due to shipping. If there is any missing part or defecting part, please contact customer service through e-mailing within 7 business days of delivery date. Please note that we will not replace any damaged products or missing parts free of charge after 7 business days of installation of the product. Feel free to contact us if you have any question with your PO number.

2. Please make sure to contact your local building codes with questions on installation standards. Building and plumbing codes may vary by location.

**Choose the Mirror direction - vertical or horizontal.
Follow the appropriate diagram below .**

Vertical Assembly

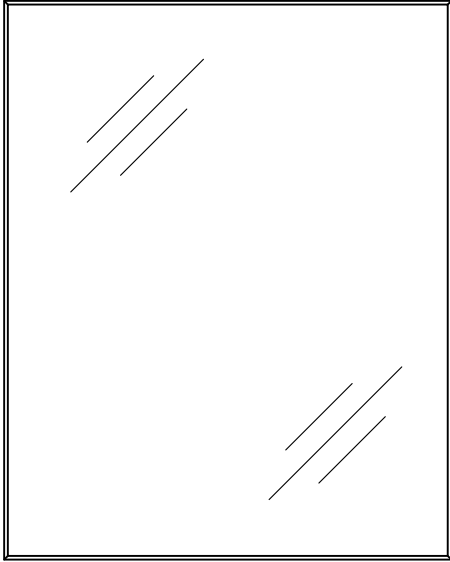

Horizontal Assembly

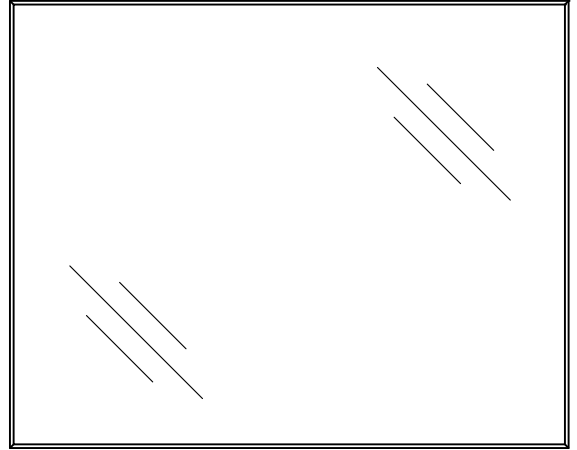

STEP 1

Select the desired position of the mirror. Level and mark the location.

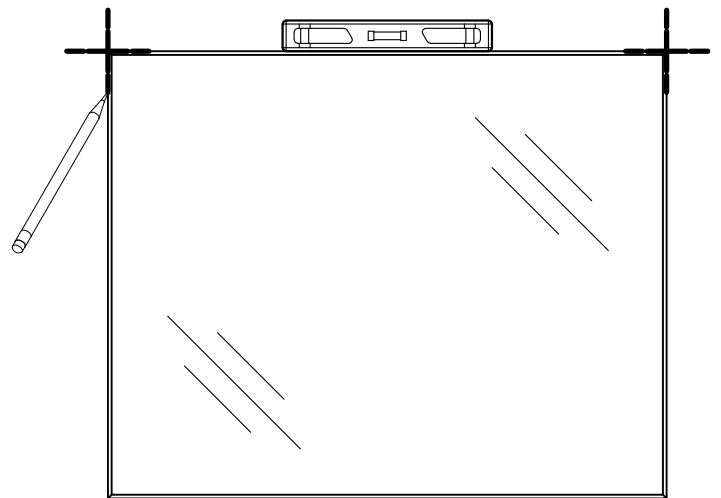
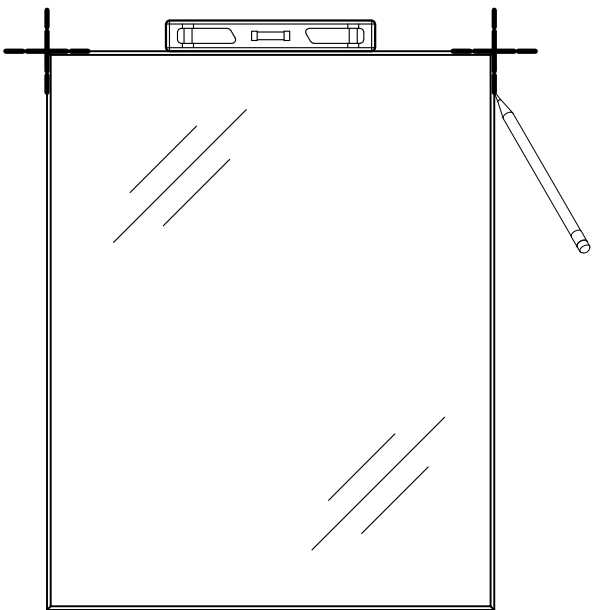

STEP 2

Mark the drilling locations and ensure marking are leveled, based on vertical or horizontal mounting. See chart below.

Model No.	Vertical Assembly (A)	Horizontal Assembly (A)
2430	2 1/4"	1 15/16"
3030	2 1/4"	1 15/16"
3630	1 15/16"	2 1/4"
4848	1 15/16"	2 1/4"
5646	1 15/16"	2 1/4"

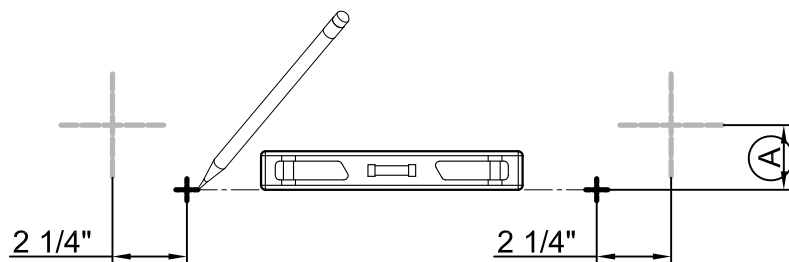

STEP 3

3.1 Drill holes about 1 1/2" deep at each of the marked locations.

3.2 Insert wall plugs (3).

For walls thicker than 3/8" to 1/2", drill a 5/16" hole and insert the WALL PLUG (3).

For walls thinner than 3/8" to 1/2", drill a 3/8" hole and insert the AIRCRAFT-SHAPED WALL PLUG (4).

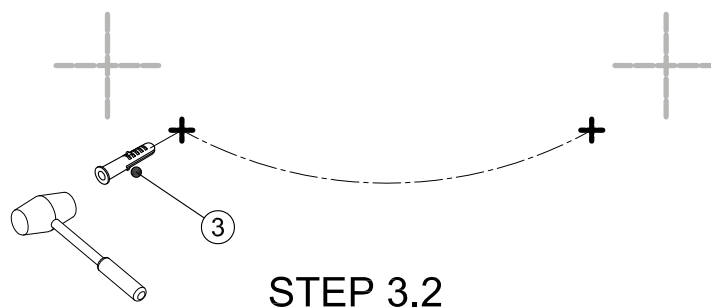
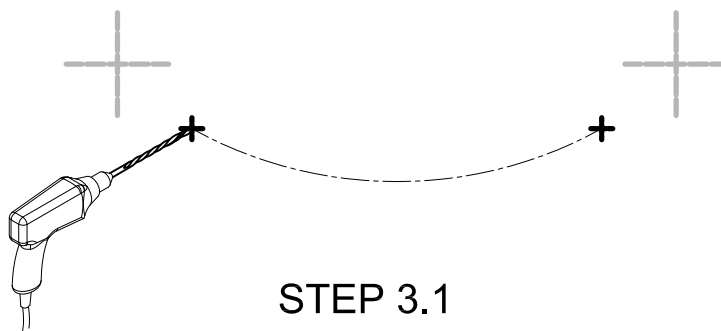

STEP 4

Install Screw ② . Leave a gap of 1/8" between the head of the screw and the wall.

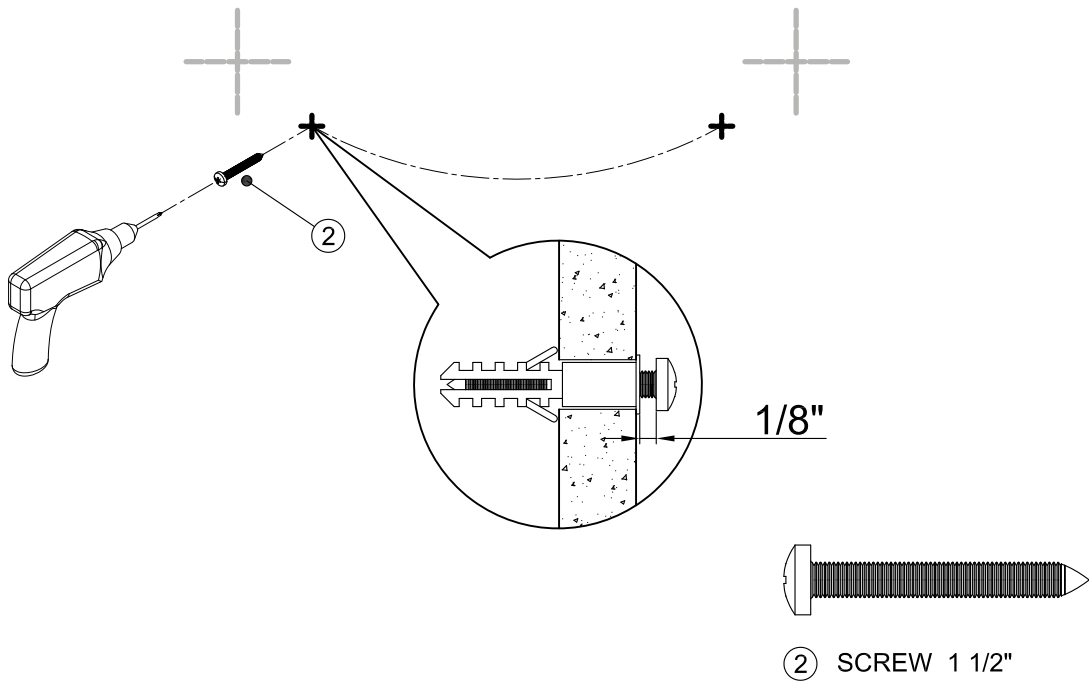

STEP 5

Tear off the double-sided tape film from Pad, place the mirror against the wall and slide it down, as shown in Figure 2.

